



**PoolWonderland.com**  
**Inground Pool Liner**  
**Measuring Form**

**Before Starting You Will Need:**  
 -Tape Measure  
 -A Straight Pole  
 -String  
 -Weight

**Helpful Tips:**  
 Measuring will always be easier with someone to help. Only Measure down to the 1/4 of an inch.

**We are Here To Help!**  
 Call Us: 1-888-317-2968  
 Fax: 1-888-494-0982  
 Email: Support@PoolWonderland.com

Return completed form via fax or email for your free price quote.

Instructions On How To Measure Can Be Found At The End Of This Form

Your Name:

Address:

City:  State:  Zip:

Phone:  Fax:

Email:

Today's Date

**Step 1 - Choose Liner Pattern & Thickness**

Pattern:

20 Mil (25 Gauge)       27 Mil (34 Gauge)

**Step 2 - Select Corner Type**

Cut Corners  
 Point 1 to Point 2:

Square Corners  
 No measurements required for square corners.

Radius Corners  
 Point 1 to Point 2:

**Step 3 - Liner Type**

Beaded  
 Low Hung Beaded  
 Overlap  
 Inches   
 Standard Bead  
 Reverse Bead

The following pages will involve measuring the pool's hopper, as well as the length and the width. Sometimes measuring can be difficult, so please feel free to contact us if you have questions on how to measure.

**Don't see your type of pool on this form? For other pool shapes visit our website for more measuring forms or give us a call!**



**PLEASE NOTE: When replacing your pool liner, it is necessary to replace all gaskets for skimmers, drains, returns, and steps, as using old gaskets will cause leakage. Don't forget to ask our liner technicians about these must-have items!**

**Step 4 - Hopper Type**

Standard Hopper

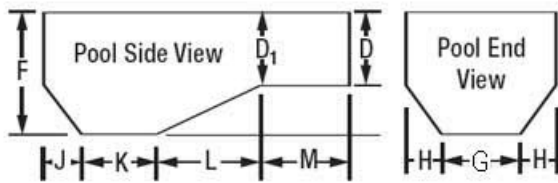

Wedge Hopper

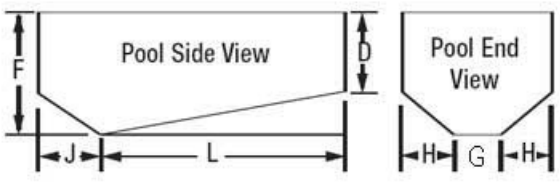

Constant Slope Hopper

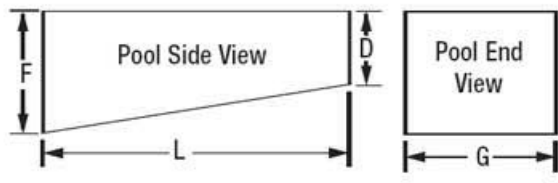

Safety Ledge Hopper

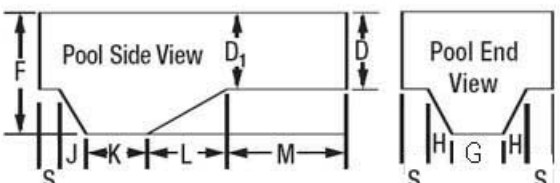

**Step 5 - Hopper Dimensions**

Please reference the hopper type for your pool from section 4. All dimensions should be measured in 1/4" increments.

D =  Feet.  Inches

D1 =  Feet.  Inches

J =  Feet.  Inches

K =  Feet.  Inches

L =  Feet.  Inches

M =  Feet.  Inches

H =  Feet.  Inches

S =  Feet.  Inches

G =  Feet.  Inches

F =  Feet.  Inches

**Very Important:**

The length dimensions that make up the the bottom must equal the total length of the pool.

For Example(Standard Hopper):  
"J"+"K"+"L"+"M" all added together must equal the pool's total length.

This is also true for the dimensions that make up the width.

For Example (Standard Hopper):  
"H"+"G"+"H" all added together must equal the pool's total width.

**Don't see your type of pool on this form? For other pool shapes visit our website for more measuring forms or give us a call!**

**Step 6 - Pool Shape**

Rectangular

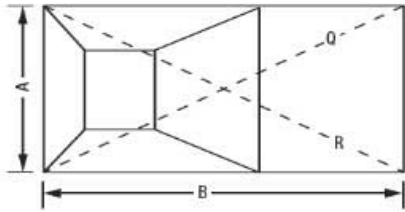

Oval w/ Parallel Sides

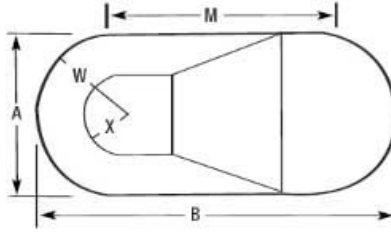

Contour Bottom Grecian

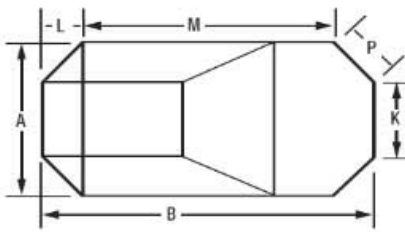
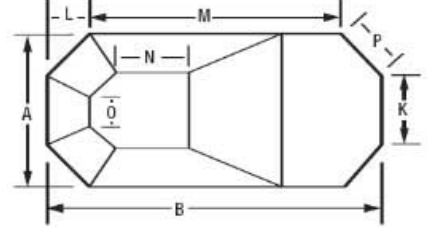

Square Bottom Grecian

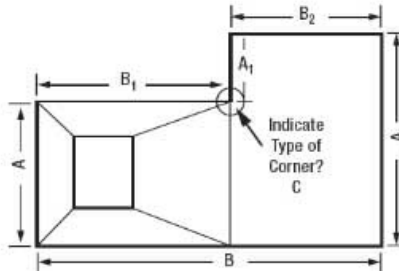

True "L" Right

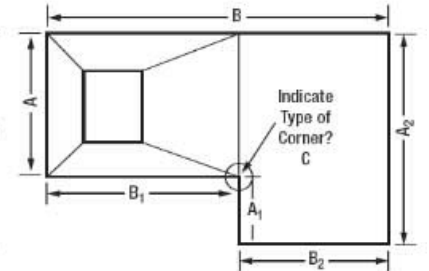

True "L" Left

A =  Feet.  Inches

A1 =  Feet.  Inches

A2 =  Feet.  Inches

B =  Feet.  Inches

B1 =  Feet.  Inches

B2 =  Feet.  Inches

K =  Feet.  Inches

L =  Feet.  Inches

M =  Feet.  Inches

N =  Feet.  Inches

O =  Feet.  Inches

P =  Feet.  Inches

Q =  Feet.  Inches

R =  Feet.  Inches

W =  Feet.  Inches

X =  Feet.  Inches

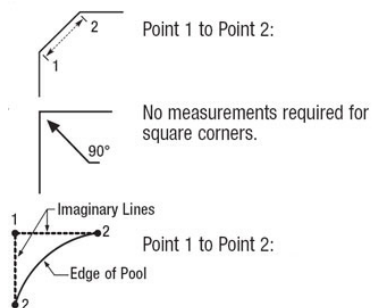

C = Corner Type (True "L" Pools Only)

Cut Corner Measurement

Square Corner (No Measurement Needed)

Radius Corner Measurement

**Step 7 - Vinyl Covered Steps**

**If your pool liner goes over your step system, you will need to fill out this section. If your pool has a one piece Fiberglass Step, or no step, you have completed all of the measurements required. No further dimensions are needed.**

**Step Position**

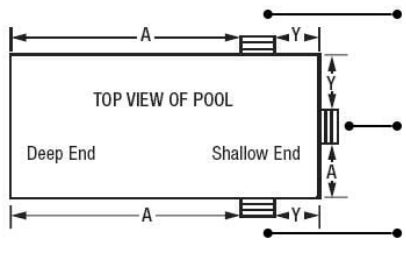

Right Hand Steps

Center Steps

Left Hand Steps

Y =  Feet.  Inches

A =  Feet.  Inches

**Step Shape**

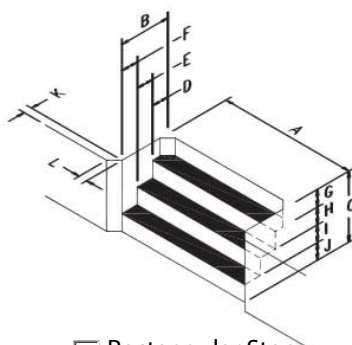

Rectangular Step

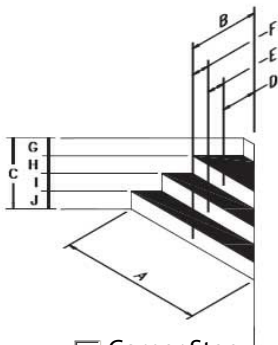

Corner Step

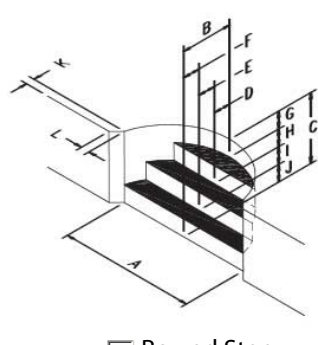

Bowed Step

A =  Feet.  Inches

B =  Feet.  Inches

C =  Feet.  Inches

D =  Feet.  Inches

E =  Feet.  Inches

F =  Feet.  Inches

G =  Feet.  Inches

H =  Feet.  Inches

I =  Feet.  Inches

J =  Feet.  Inches

K =  Feet.  Inches

L =  Feet.  Inches

"C" must equal shallow end wall height (Step 5, dimension "D")

"D"+"E"+"F" must equal dimension "B"

"G"+"H"+"I"+"J" must equal dimension "C"

Step Setback? Dimension "K"  Yes  No

Is Step Setback 45 Degree  Yes  No

Top Rear Step Corners  
 Square  Radius\*  Diagonal\*

Are Rod Pockets Needed?  Yes  No

Rod Diameter

\*Top Rear Step Corner Measurement  Inches

## How To Measure

### Measuring Without Entering The Pool:

You will be able to measure horizontally, all of the bottom dimensions without entering the pool. You can use a simple measuring tool that will take about 5 minutes to assemble & is used by pool professionals taking liner measurements.

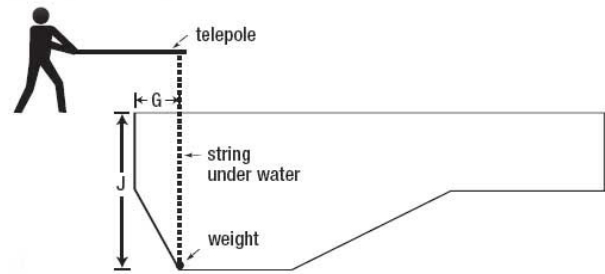

### You Will Need:

- A Long Straight Pole (Vac Pole) - "Fishing Pole"
- String Attached To End Of Pole
- Weight To Attach To End Of String
- A Measuring Tape

**Follow the instructions below, using the "Fishing Pole" to make measurements.**

### Horizontal Bottom Measurements:

Use your "Fishing Pole" to "Fish" for a point on the bottom of the pool.

With the pole to the ends of the pool and the string vertical (allow no slack in the string), measure the distance from the edge of the pool (water's edge) to the end of the pole where the string is attached.

You should "Fish" for points that will achieve the desired measurements based on the bottom contour of the pool.

For example to take measurement "H", you would stand on one side of the pool, and "Fish" for a corner of the hopper. You would then measure the distance from the water's edge to the end of the pole where the string is attached.

### Depth Measurements:

When taking the depth measurements, be sure to measure from the bottom of the pool floor to the bead receiver (beaded liners only), or to the board where the liner is nailed or stapled (Overlap Liners). Do not measure to the top of the pool if you have a beaded liner, this will be incorrect & liner will not fit as it should.

**If you have any questions on how to measure please feel free to contact us at 1-800-317-2968**

***You can view all of our patterns at: [www.PoolWonderland.com](http://www.PoolWonderland.com)***

**This form can be faxed or sent via email for same day quote for most pool shapes.**

***We guarantee the lowest price on any size and any shape Inground pool liner.***

**Don't see your type of pool on this form? For other pool shapes visit our website for more measuring forms or give us a call!**